

# Teensy bat detector construction manual v0.8 PCB

Cor Berrevoet's version of Frank DD4WH's bat detector idea, PCB design and some optimization by Edwin PE1PWF testing and assisting in development Thierry Arbault and Adrian Dexter

Board version 0.8 Teensy4.1 22-09-2022

Visual representation of the received sounds.

3 listening modes:

- Auto Heterodyne,
- Heterodyne,
- Time Division

High recording sample rates, up to 384kHz

Check <https://forum.pjrc.com/threads/38988-Bat-detector> for more information on the project, code and discussion. Or see [www.teensybat.com](http://www.teensybat.com).

Edwin, 08-01-2023

In this document I will try to describe what you need to build this detector.

The PCB version has changed to V0.8 and pictures in this manual show V0.7 but building is not any different. Also the same component positions apply so the enclosure of the V0.7 PCB will also fit.

Apart from the PCB we need:

- 1x Teensy 4.1 development board (without headers)
- 2x PSRAM 8MB (APS6404L-3SQR-SN or ESP-PSRAM64H) Optional but highly recommended!
- 1x 2.8" ILI9431 colour TFT display with Q1 for backlight control and no touch! (red PCB)
- 1x Lithium cell like 126090, 106090 or 606090 (or 2x 606090)
- 2x Rotary encoder with switch EC11 + knobs
- 2x momentary push switch + knobs (8x8mm dpdt + 7mm knob and 12 IC socket pins for elevation)
- 1x slide switch SK12F14, 5mm handle
- 1x SPU0410LR5H-QB microphone on PCB
- 1x 3\*1 pin header right angle
- 2x 24\*1 pin female header, extra low (PH3.5)
- 2x 24\*1 pin male header extra low (for PH3.5)
- 1x single pin header female extra low (PH3.5)
- 1x single pin header male extra low (for PH3.5)
- 1x 14\*1 pin female header, regular height
- 1x 4\*1 pin female header, regular height
- 1x 4\*1 pin male header, regular height
- 1x 3.5mm stereo jack socket PJ-313
- 1x CR2032 coin cell
- 1x coin cell holder for CR2032
- 1x Project Box 116x68x36mm Black
- 4x screws 2.2X12mm
- 1x foam pad "donut" for microphone seal



## What tools do we need?



Soldering iron. Something like 30 watts is fine enough, be sure to have a clean tip.

Solder should be a resin core solder, do not use any other kinds of flux or soldering agents.



A fine cutter to clip ends of the microphone headers or other wires.

Some screwdriver (Philips #1)



Some files just in case the enclosure does not fit well enough.

## Optional tools



Desolder pump or wick to remove solder, just in case something went wrong.



A pair of tweezers could be useful and also this kind of tip cleaner is something I like to use.



In this picture are most parts that we need to build the Teensybat detector

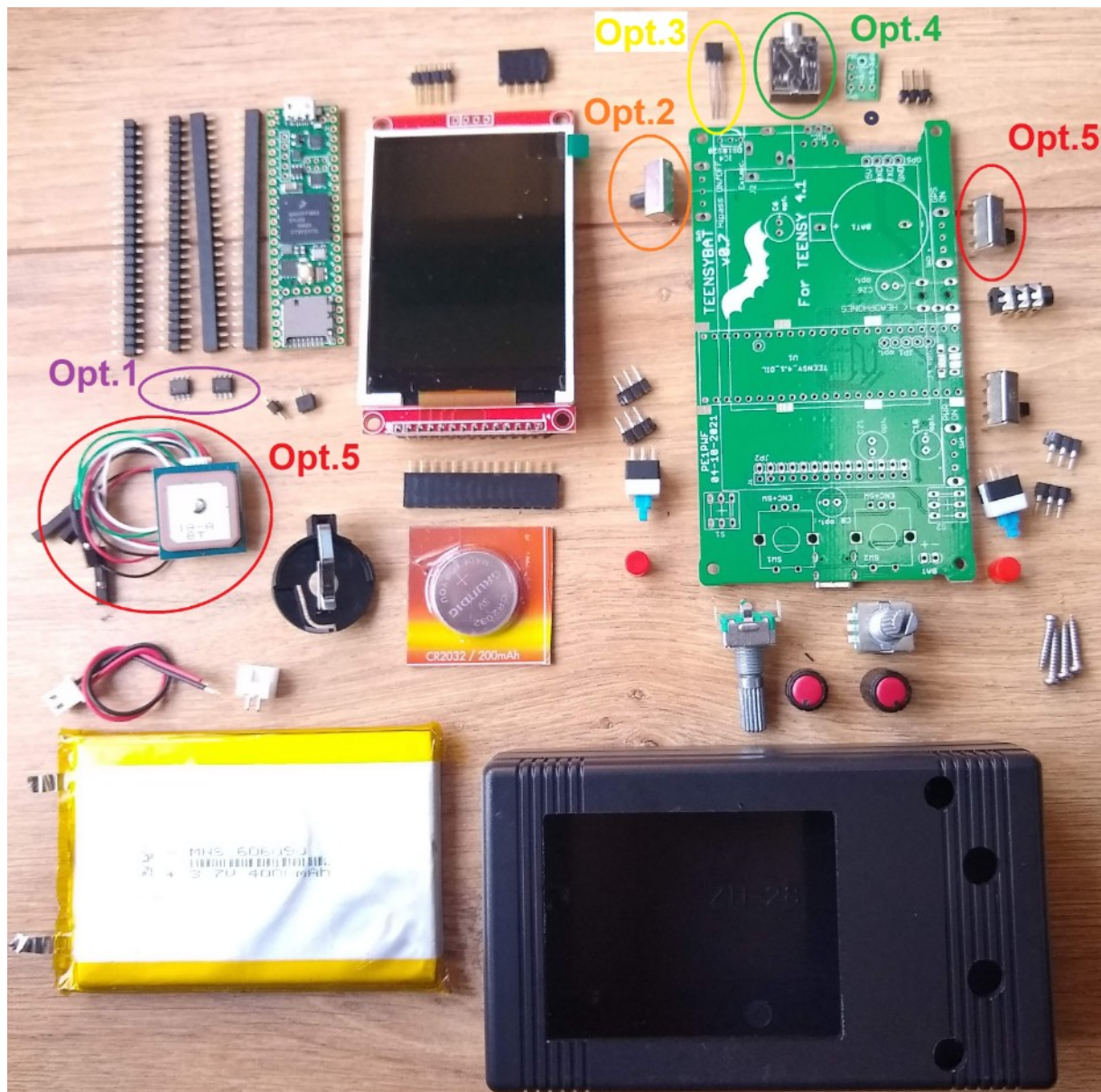

There also are some optional parts:

Option 1, is highly recommended, 2 chips 8MB Ppsram APS6404L-3SQR-SN or ESP-PSRAM64H.

Option 2 is an extra switch to bypass the high-pass filter (the hardware high-pass filter does not cut but only dampen the lower frequencies). (SK12F14 5mm handle)

Option 3 is a Dallas DS18B20 or DS18S20 thermometer chip. Nice for temperature indication but since it is close to the detector and your hands it is not extremely accurate.

Option 4 is a 3.5mm TRS jackplug socket which can be used for an external microphone. T= +3.3V, R=mic signal, S=GND (PJ-324)

Option 5 is a GPS receiver and switch. The GS receiver consumes quite a bit of current, it also need some additional shielding. There is a lot of data being processed in the detector which seems to interfere with GPS reception. Reasonable reception we need to shield the Teensy and absorb unwanted RF signals. (Beitian BN-180 or BN220 should file fine) + switch (SK12F14 5mm handle)

### The Build.

So most parts are already mounted on the PCB, we only need to solder the larger through hole style parts.

Unfortunately there is one tricky part and that is the memory on the Teensy

I usually put solder on only one pin, heat the solder back up again and move the right pin in place.

After positioning solder the rest of the pins.

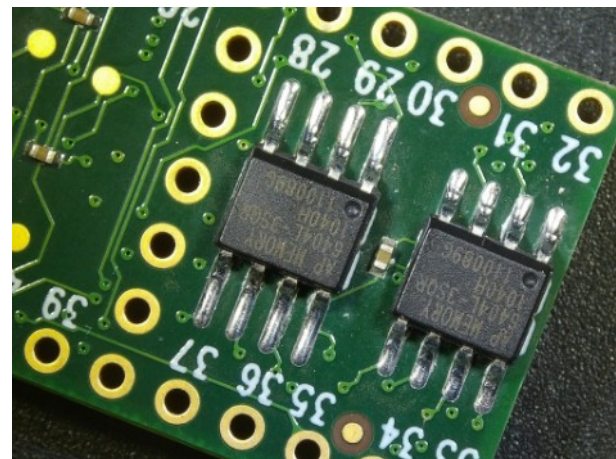
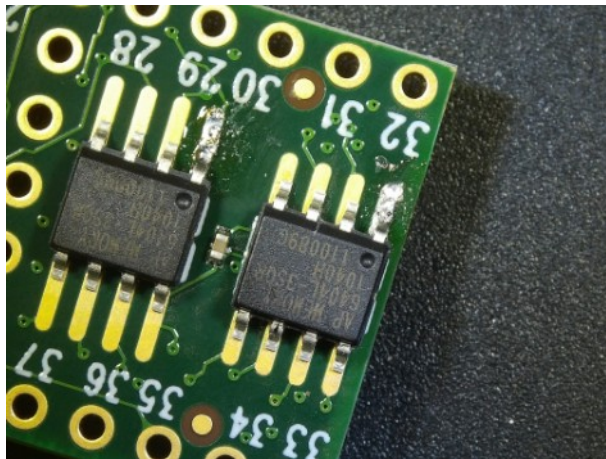
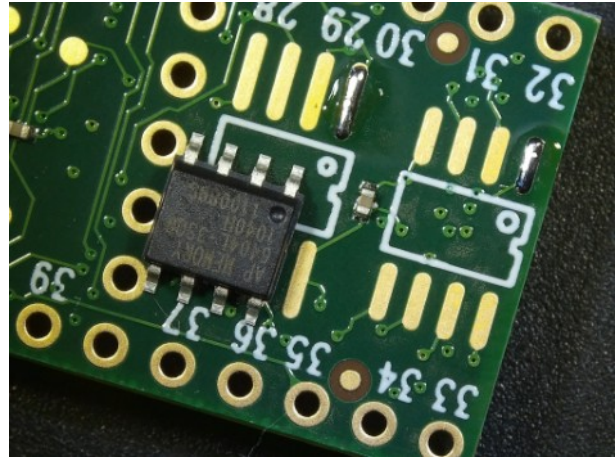
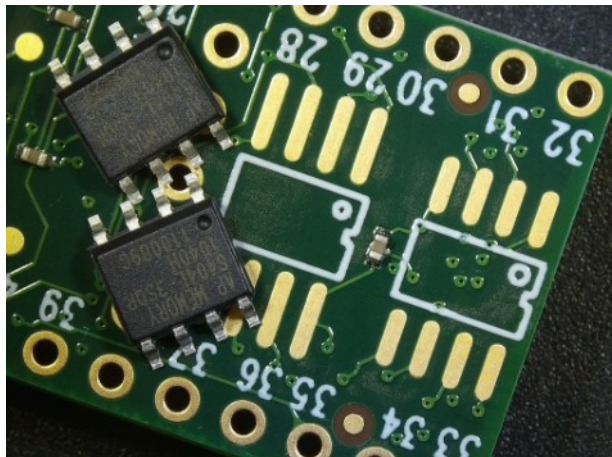

If you somehow soldered all pins of these small IC's together there is no need to worry.

Hold the PCB and soldering iron vertical and heat the pins of one IC all in one go and move the soldering iron downwards. Most of the solder will run off the IC-pins to the soldering iron.

If you managed to solder this, you have managed the most tricky part.

These memory IC's are optional, but they make a nice audio buffer so is very much recommended.

The buffer allows you to store the sounds you just heard, so when you press record, recording will start but the past few seconds are stored in the beginning of the recording.

**The Mainboard.** Now we can start to solder headers. The female headers sit on the mainboard.

The male headers go into the Teensy. You can see two raised edges (spacer) on the end the touches the circuit board.

Do not forget the single header pin for the backup battery power to the Teensy.

I usually press the male and female header together, put then in the mainboard and use the Teensy to make sure they are aligned properly. Now simply solder all pins on the Mainboard and the Teensy.

GPS users might want an RF absorber on the mainboard between the headers. Place this before putting the Teensy in place.

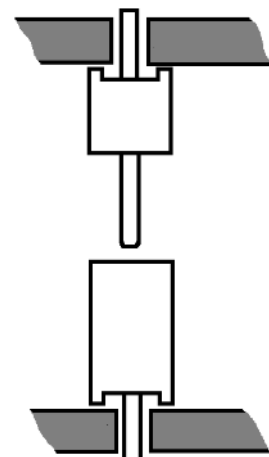

Solder the encoders, switches, coin cell holder, headphone connector and remaining headers.

For the display we have two different header positions. Please check what version display you have.

The SD-card connector needs to be removed from the display, one does not need to be gently, there are no important tracks near the cardsocket. The 4pin connector only needs soldering on all pins to keep the display in place.

Just make sure your display has the Q1 transistor for backlight control.

This is a good Display

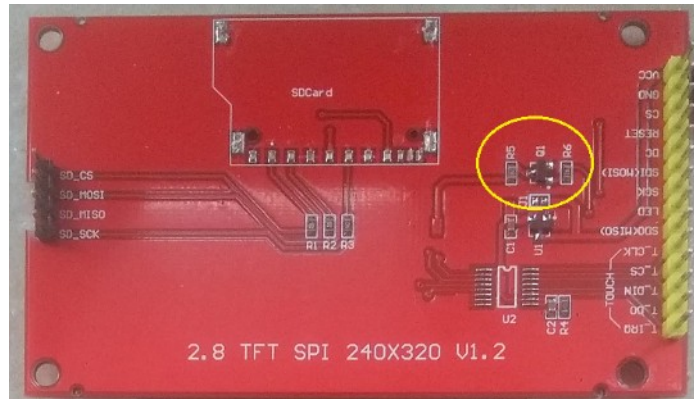

This one also has the Q1 transistor

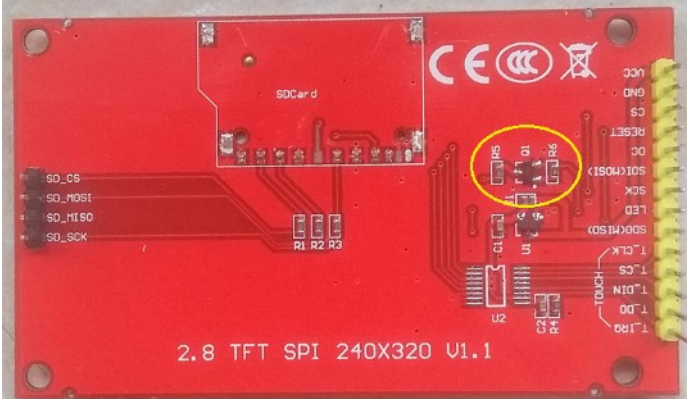

Here is a display board without the Q1 transistor. **Do not use this version!**

The version number of both is 1.1 so check for Q1 on the PCB.

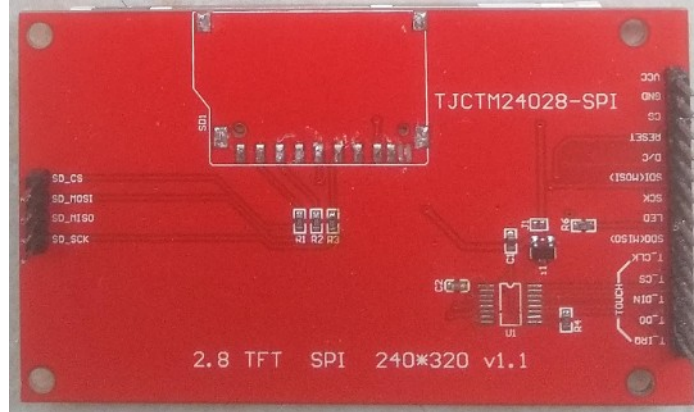

This is an other version of the 2.8" display it has Q1 but is 2.5mm shorter than the other displays.

Just use the right header position on the mainboard.

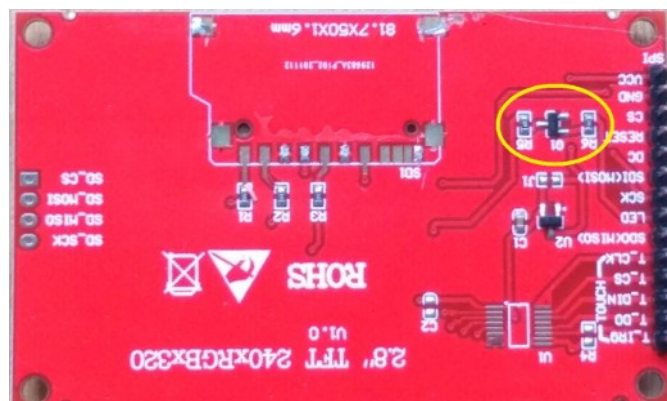

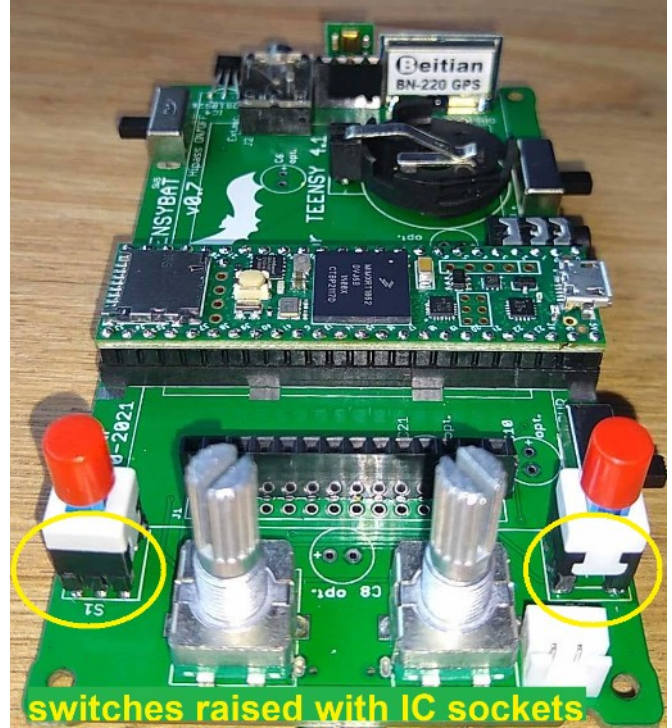
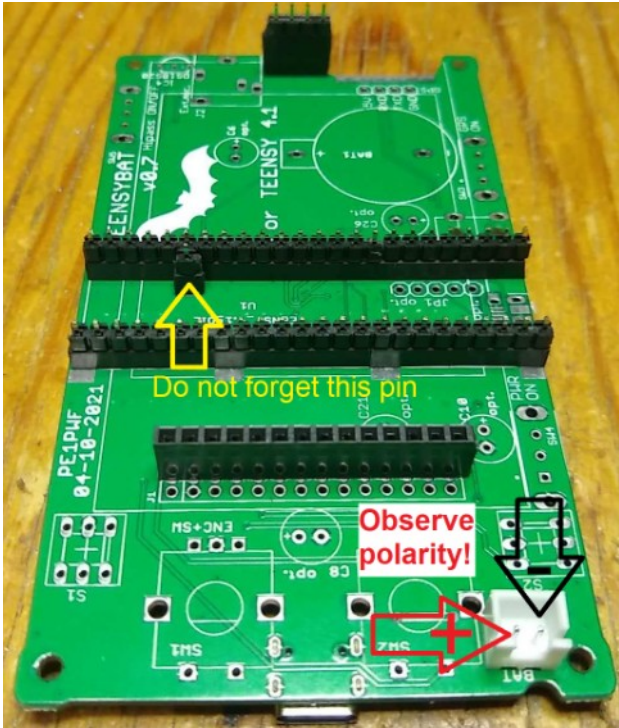

The circuit board should make it quite clear where parts need to be placed.

Take special care when connecting the battery connector! Some li-po cells come with wires and a connector which might not have the same connection.

The switches need to be raised by a few millimetres (only for 7mm knob). This is done by placing IC sockets in the PCB and place the switches in these sockets. (with 10mm knob you can do without these IC socket-pins)

Underneath the teensy there are five extra pins (JP1) for those of us who like to experiment with an extra USB port. We do not need these five pins and the USB connector (J4).

**The lines below do not apply for the V0.8 PCB**

*There are also several positions for extra electrolytic capacitors. C6,8,10,21 and 26 are marked as Opt. These are optional, just in case the small SMD parts on the bottom side were not sufficient. It does not seem to be necessary to place any capacitor there.*

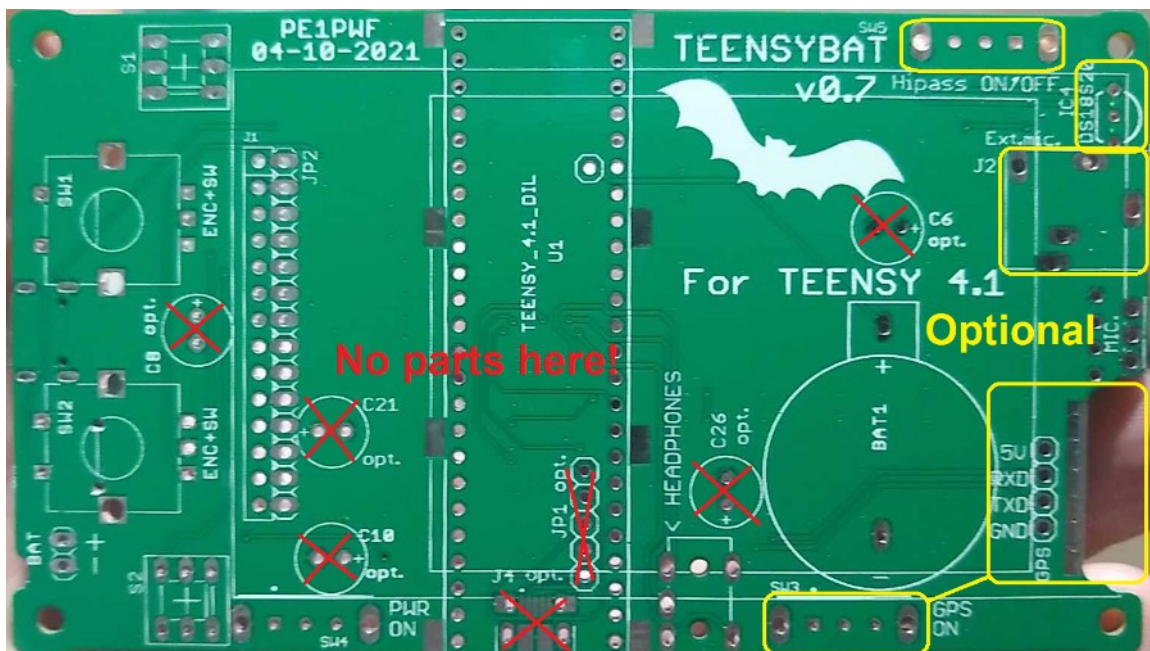

## Battery.

The battery we can use is any size or style Lithium-polymer cell. We simply use a single 3.7 volt cell, or two in parallel so it will be only 3.7V.

I like to use 606090 106090 or 126090 cell's because they are a nice size. 6X60x90mm, 10x60x90mm or 12x60x90mm the capacity should be around 4000-6000 or 8000mAh. Simply connect the battery to the input pins of the TeensyBat mainboard, there is a battery protection circuit on the mainboard. But for good measure it is best to apply as **small glass fuse of about 2A** directly to the plus terminal of the battery. **Please mind + and - connections!**

**The microphone** is an extremely important part of the detector. PCB is placed on the right angled header in such a way that the bottom of the microphone PCB is almost touching the mainboard. You could choose to solder only one pin so you can adjust it easily when trying it in the enclosure. Be sure to clip the pins at the front as short as possible so the microphone board can touch the inside of the enclosure.

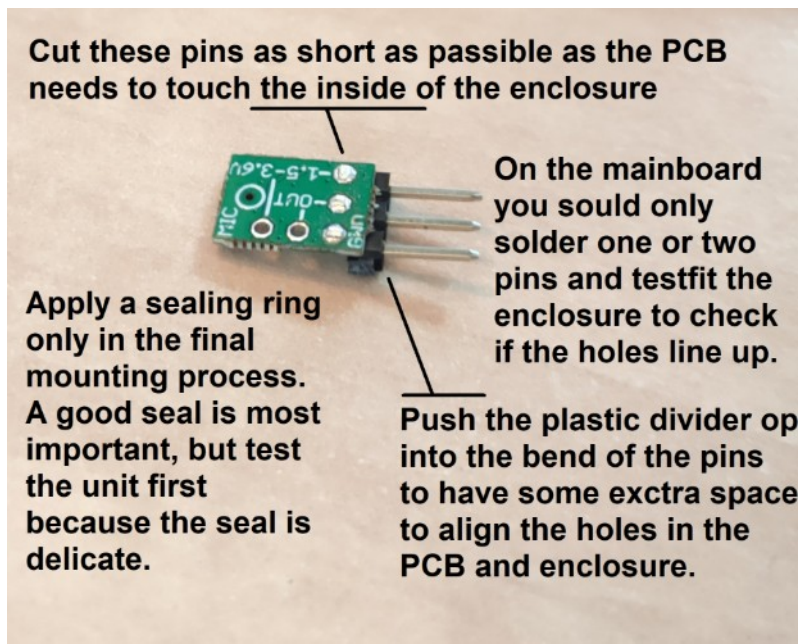

Take special care that the microphone lines-up with the hole in the front of the housing and makes a good seal.

I usually use a 1mm thick self adhesive foam pad cut in the shape of a donut about 5mm diameter with a 2mm hole.

If the seal to the enclosure is not good enough the detector will probably still work fine, but you could find extra noise in the recordings.

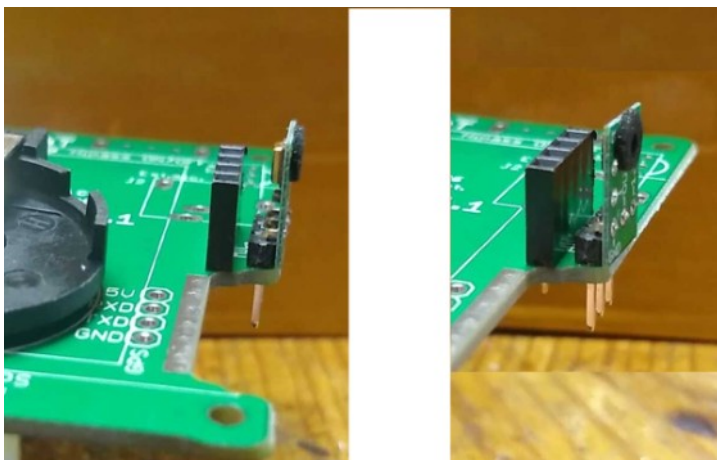

The foam sealing pad should be placed when all is finished and tested and you are ready to put the whole assembly in the enclosure.

The glue on the pad will go soft once you heat up the microphone during soldering. And it is easy to damage during mounting so wait until the very last moment.

It is a bit tricky to put the whole assembly in the housing, to get a good seal of the microphone against the housing I use a doughnut shaped foam pad. I put the mainboard in the lower part of the enclosure and put the top part over it. Aligning the switches but pushing the top part to the front so it does not touch the seal that much and press it together. You might need to tuck in the seal a little but that is fine.

### Optional Features.

There are a few optional components.

1<sup>st</sup> there are the extra Memory chips, I think these are adding a great feature so I do not even consider these optional. The Detector will work without but being able to store the sounds from a few seconds ago is a great feature.

2<sup>nd</sup> An extra switch to bypass the lowpass filter in the hardware. This lowpass filter is not a very steep and deep filter. It does suppress low frequency sounds a bit so there is less chance of harmonics for low frequencies. This switch can bypass this filter.

If you do not need a switch and do not want a high-pass filter you can close solder-jumper SJ3

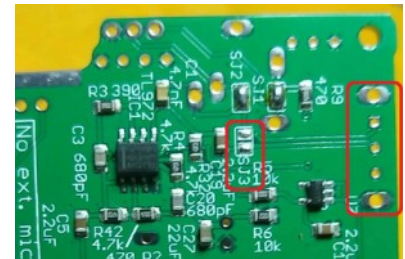

3<sup>rd</sup> A Dallas DS18B20 temperature sensor, mount this so it can stick out of the enclosure.

4<sup>th</sup> This is a jack plug socket to be able to attach an external microphone. There is an internal switch in this socket, if you do not use the socket, short solder jumpers SJ1 and SJ2. For testing purposes I might have closed JS1 and SJ2, if you do place the 3.5mm socket you may need to pen these solder jumpers again.

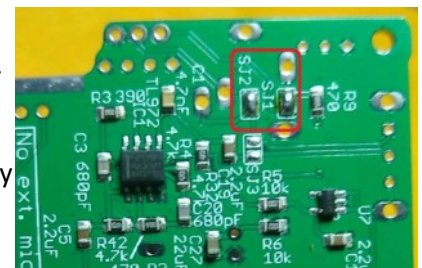

5<sup>th</sup> is the GPS, this actually is one of the best options to add, but the GPS signal can be easily disturbed by the very busy data signals in the detector.

For the GPS to be able to function reasonably, we also need to have shielding over the Teensy and it helps to decouple RF from the power and data lines of the GPS module as well as absorbing unwanted RF/EMC interference.

The metal shield GPS module simply is soldered to the front end of the PCB, for this we need to remove the label on the back (partially). Simply put the GPS unit in place, touching the display PCB and solder the metal shield to the top and bottom of the mainboard.

Now solder the wires and keep them short. Observe the colours, and be sure to save some space for the battery. (try to keep the wires to the side of the connector)



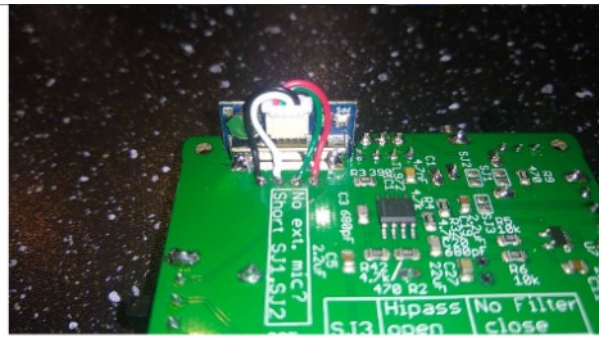

I used some RF absorbing sheet under the Teensy and also directly under the metal shield. Under the shield is only a little space, 0.5mm thick RF absorber is fine you can see I even cut out a part where it could touch a capacitor. The thicker the material the more signal it can absorb, you could even try stacking layers to have better GPS reception.

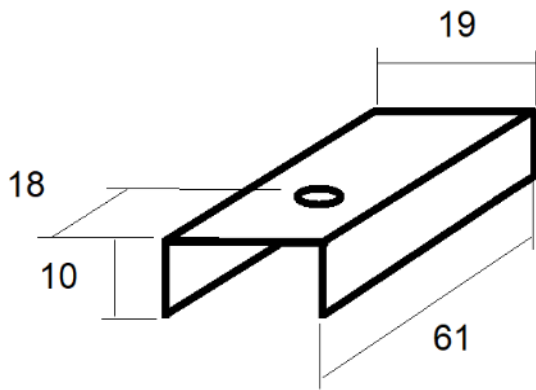

The metal shields I use a tin plated steel sheets from the local cannery, this is very thin material.

I make a hole above the reset switch so it is accessible, this thin material is hard to drill into. Grind your drill bit so that it centers but cuts through the outer edge first, like this on the right.



It might be wise to make holes in places where the parts of the display could touch. And put a piece of tape on the shield because the display can come very close to the shield.

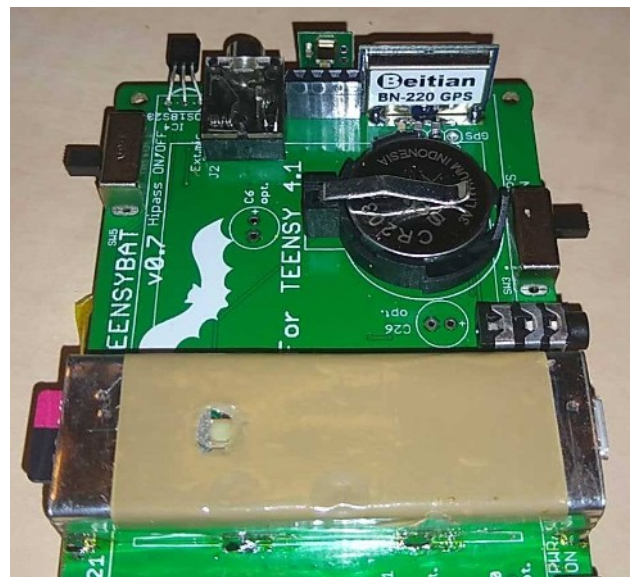

As extra measures you could try to add some decoupling capacitors over supply line (5V is actually V-bat, approx. 3.7V) and the data lines. Keep those capacitors very small. Larger values will have bad influence on the data signals.

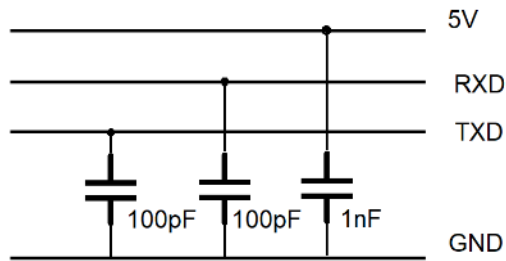

Schematic

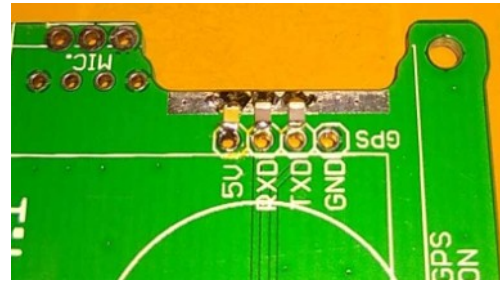

Extra capacitors placed near the GPS pads.

### Installing the software. (Using windowsXP or later)

Go to [www.Teensybat.com/software](http://www.Teensybat.com/software) and download the latest software and update tools.

Unzip the files and read the txt file for instructions, on Windows 10 simply plugin the teensy USB and install the driver which is already present in Windows10.

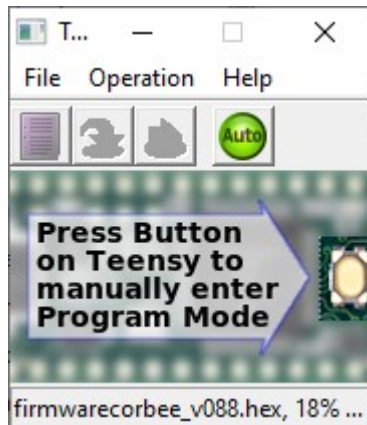

Run Teensy.exe

Select File and choose the right "teenybat".hex file

Click the dark green button so it lights up and you can read "Auto"

now run reboot.exe (if you can reach the small switch on the teensy you can press that instead)

The Teensy reboots and loads the new software.

**On Linux you might need to install all Arduino, Teensyduino and the program source.**

<https://www.arduino.cc/>

<https://www.pjrc.com/teensy/teensyduino.html>

The project files from Cor Berrevoets contain other updated files.

Check out Cor's github pages. [https://github.com/CorBer/teensy\\_batdetector](https://github.com/CorBer/teensy_batdetector)

### Testing.

With the display in spectrum mode you should see a whistle as a strong peak on the left of the display. Rubbing your hands together near the microphone you should see a wider signal near about 20-30Khz.

Pointing the detector towards a switching power supply, like your phone charger or computer/laptop power supply or a TV should give some peaks around 30-60Khz.

You could also dangle a keyring with some keys in front of the microphone. These give a loud noise over just about the whole spectrum. If you dangle your keys close to the microphone you can set the gain to 0 and still have strong signals.

For a wideband ultrasound source you can use some "white water" from a faucet with perlator. I often use this to test because it makes a reliable and reproducible sound.

**Hole positions in the enclosure.**  
(European projection)

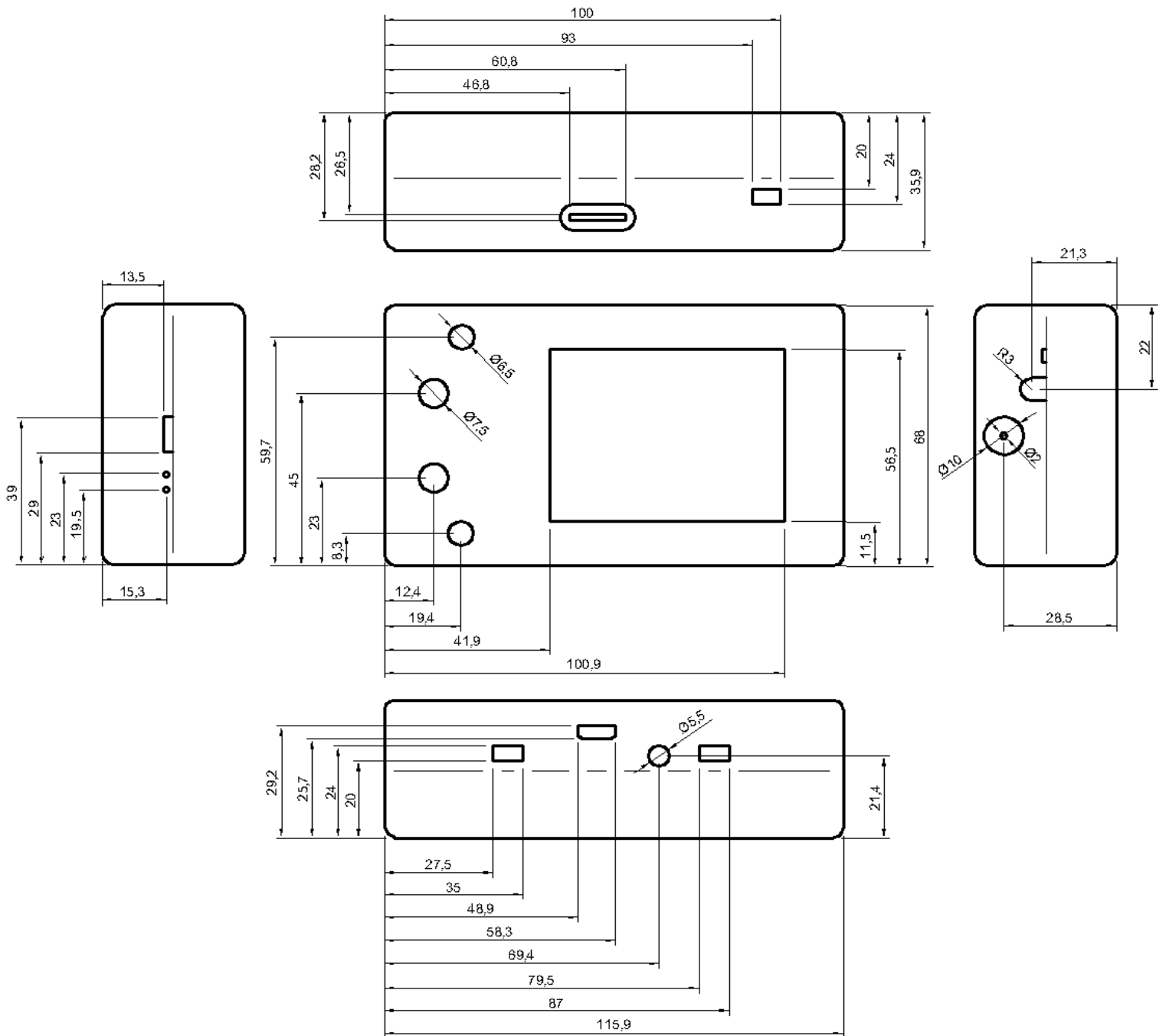

I usually extend the holes for the switches and external microphone to the edge of the enclosure (where both half's meet) to allow for easy fitting.

On the next page is the schematic of the v0.8 PCB.  
It is a little crowded, I'm not very pleased with the looks but you'll have to do with it.

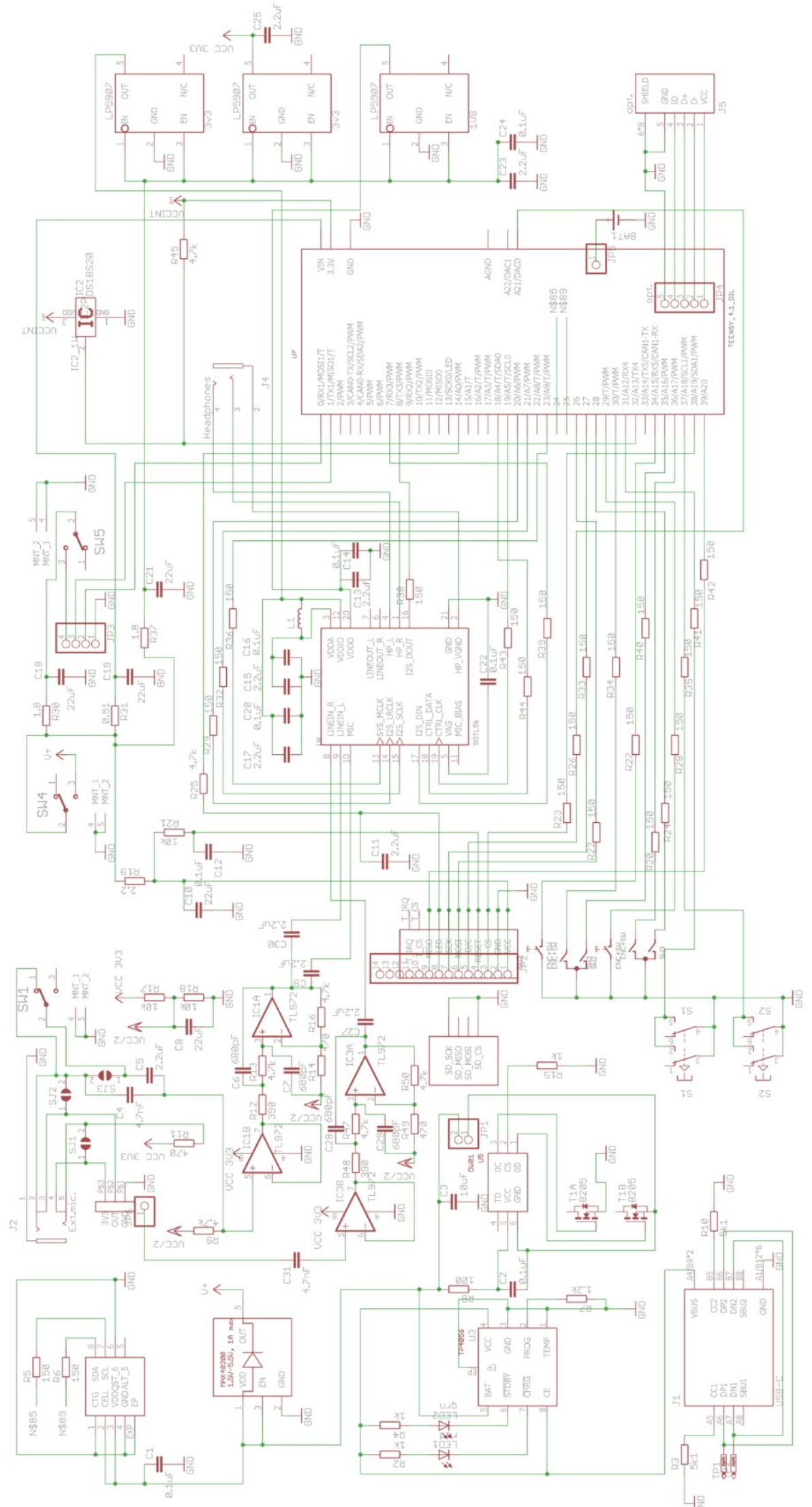

TEENSY\_4.1\_BILL

0/RX1/MISO1/T	10B
1/PWM	10B
2/PWM	10B
3/CAN0-TX/SDA2/PWM	10B
4/CAN0-RX/SDA3/PWM	10B
5/PWM	10B
6/PWM	10B
7/RX3/PWM	10B
8/RX3/PWM	10B
9/RX2/PWM	10B
10/RX2/PWM	10B
11/MISO0	10B
12/MISO0	10B
13/SCK0/LED	10B
14/A0/PWM	10B
15/A1/T	10B
16/A2/T/PWM	10B
17/A3/T/PWM	10B
18/A4/T/SDA0	10B
19/A5/T/SCL0	10B
20/A6/PWM	10B
21/A07/PWM	10B
22/A87/PWM	10B
23/A97/PWM	10B
24	10B
25	10B
26	10B
27	10B
28	10B
29/T/PWM	10B
30/T/PWM	10B
31/A13/RX4	10B
32/A13/TX4	10B
33/A15/RX5/CAN1-TX	10B
34/A15/TX5/CAN1-RX	10B
35/A16/PWM	10B
36/A17/PWM	10B
37/A18/SCL1/PWM	10B
38/A19/SDA1/PWM	10B
39/A20	10B

UP

VIN	3.3V
GND	
AGND	
A22/DAC1	
A31/DAC0	
N\$85	
N\$89	
25	
26	
27	
28	
29/T/PWM	
30/T/PWM	
31/A13/RX4	
32/A13/TX4	
33/A15/RX5/CAN1-TX	
34/A15/TX5/CAN1-RX	
35/A16/PWM	
36/A17/PWM	
37/A18/SCL1/PWM	
38/A19/SDA1/PWM	
39/A20	

J1

AS	5k1
A5	
A3	
A2	
A1	
A0	
SBU1	
SBU2	
DN1	
DN2	
DP2	
CC1	
VBUS	
AJ19*2	
R10	
S4*1	
AJ18*6	
GND	
USB-C	

J2

1	
2	
3	
4	
5	
6	
7	
8	
9	
10	
11	
12	
13	
14	
15	
16	
17	
18	
19	
20	
21	
22	
23	
24	
25	
26	
27	
28	
29	
30	
31	
32	
33	
34	
35	
36	
37	
38	
39	
40	
41	
42	
43	
44	
45	
46	
47	
48	
49	
50	
51	
52	
53	
54	
55	
56	
57	
58	
59	
60	
61	
62	
63	
64	
65	
66	
67	
68	
69	
70	
71	
72	
73	
74	
75	
76	
77	
78	
79	
80	
81	
82	
83	
84	
85	
86	
87	
88	
89	
90	
91	
92	
93	
94	
95	
96	
97	
98	
99	
100	

J5

1	VCC
2	D-
3	D+
4	ID
5	GND
6	SHIELD
7	
8	
9	
10	
11	
12	
13	
14	
15	
16	
17	
18	
19	
20	
21	
22	
23	
24	
25	
26	
27	
28	
29	
30	
31	
32	
33	
34	
35	
36	
37	
38	
39	
40	
41	
42	
43	
44	
45	
46	
47	
48	
49	
50	